

Artikel Nr.: 180515

Netzgerät, BASIC, DIM, CV, HALOGEN, Ultra 70











IP20 

Elektrische Daten

Betriebsart	spannungskonstant	Eingangsspannung	220-240V AC/50-60Hz
Leistung	0-70,00 W	Leistungsfaktor	
Ausgangsspannung	11,5V AC	Anschlußmöglichkeit	Klemme
Ausgangsstrom	0-6000 mA		

Produkteigenschaften

 Schutzklasse II	 Überspannungsschutz
SELV Schutzkleinspannung	 Lampenbetriebsgerät 110
 Kurzschlußfest	 Möbeleinbau geeignet
 Überlastschutz	ErP Standby-Stromverbrauch < 0,5 W
 Übertemperaturschutz	LVD Sicherheit nach EN 61347
 Sicherheitstrafo	EMC Funkentstörung + Störfestigkeit nach EN 55015 + EN 61547
 dimmbar - Phasen-/abschnitt	EMC Netzstromoberwellen + Flicker nach EN 61000-3-2 + EN 61000-3-3

Schwarze Felder sind zutreffend / graue Felder sind nicht zutreffend

Artikel Nr.: 180515

Netzgerät, BASIC, DIM, CV, HALOGEN, Ultra 70

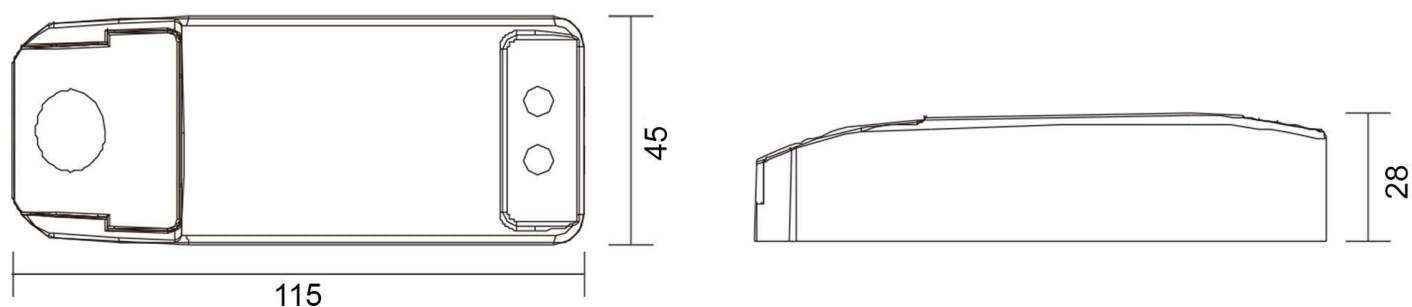
**Abmessungen und Gewicht****Grenzwerte**

Länge	115,00 mm	Betriebstemperatur	
Breite	45,00 mm	Gehäusetemperatur	80,00
Höhe	28,00 mm		
Durchmesser	0,00 mm		
Gewicht	109 g		

Article No.: 180515

Power supply unit, BASIC, DIM, CV, HALOGEN, Ultra 70











IP20 CE

Electrical Characteristics

Operating mode	constant voltage	Input voltage	220-240V AC/50-60Hz
Power	0-70,00 W	Power factor	
Output voltage	11,5V AC	Connection possibility	clamp
Output current	0-6000 mA		

Product features

	Protection class II		Overvoltage protection
SELV	Low voltage protection		Lamp control gear 110
	Short circuit protection		Suitable for furniture installation
	Overload protection	ErP	Standby-power consumption < 0,5 W
	Overheating protection	LVD	Safety according to EN 61347
	Safety transformer	EMC	Interference suppression + immunity according to EN 55015 + EN 61547
	dimnable - leading/trailing edge	EMC	Mains harmonics + flicker according to EN 61000-3-2 + EN 61000-3-3

Black fields are applicable / gray fields are not applicable

Article No.: 180515

Power supply unit, BASIC, DIM, CV, HALOGEN, Ultra 70

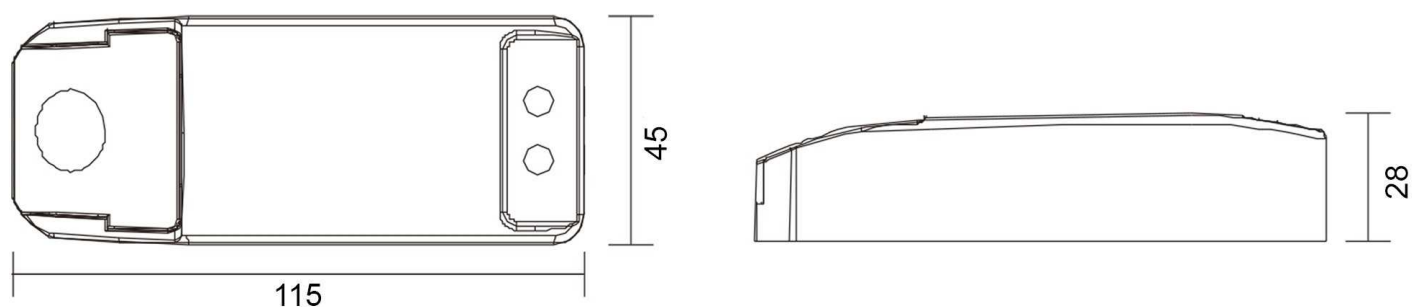

Dimensions & Weight

Absolute maximum ratings

Length	115,00 mm	Operating temperature	
Width	45,00 mm	Case temperature	80,00
Height	28,00 mm		
Diameter	0,00 mm		
Product weight	109 g		