

**Artikel Nr.: 862121**

Netzgerät, FLAT, CV, UT12V/50W











IP20 CE

**Elektrische Daten**

Betriebsart	spannungskonstant	Eingangsspannung	100-240V AC/50-60Hz
Leistung	50,00 W	Leistungsfaktor	0,95
Ausgangsspannung	12V DC	Anschlußmöglichkeit	Klemme
Ausgangsstrom	0-4160 mA		

**Produkteigenschaften**

	Schutzklasse II		Überspannungsschutz
SELV	Schutzkleinspannung		Lampenbetriebsgerät 110
	Kurzschlußfest		Möbeleinbau geeignet
	Überlastschutz	ErP	Standby-Stromverbrauch < 0,5 W
	Übertemperaturschutz	LVD	Sicherheit nach EN 61347
	Sicherheitstrafo	EMC	Funkentstörung + Störfestigkeit nach EN 55015 + EN 61547
	nicht dimmbar	EMC	Netzstromoberwellen + Flicker nach EN 61000-3-2 + EN 61000-3-3

Schwarze Felder sind zutreffend / graue Felder sind nicht zutreffend

**Artikel Nr.: 862121**

Netzgerät, FLAT, CV, UT12V/50W

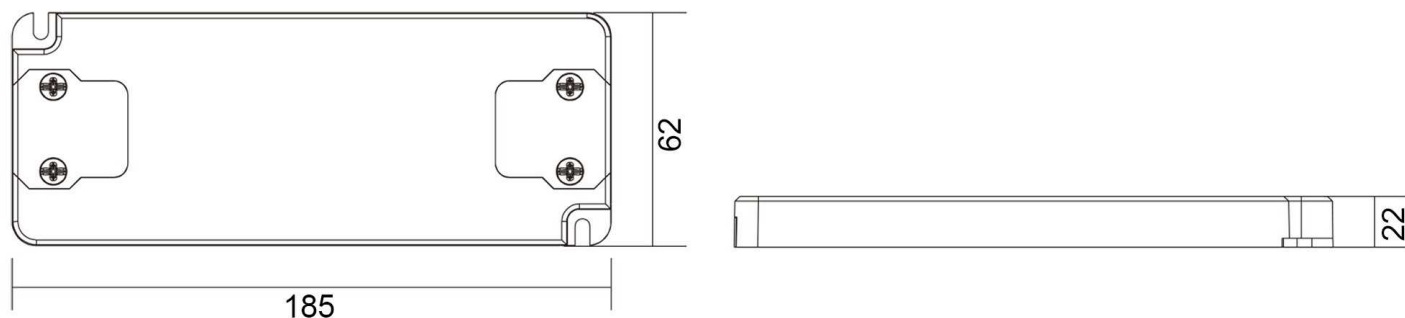
**Abmessungen und Gewicht****Grenzwerte**

Länge	185,00 mm	Betriebstemperatur	-20°C - +50°C
Breite	62,00 mm	Gehäusetemperatur	85,00
Höhe	22,00 mm		
Durchmesser	0,00 mm		
Gewicht	232 g		

Article No.: 862121

Power supply unit, FLAT, CV, UT12V/50W











IP20 CE

### Electrical Characteristics

Operating mode	constant voltage	Input voltage	100-240V AC/50-60Hz
Power	50,00 W	Power factor	0,95
Output voltage	12V DC	Connection possibility	clamp
Output current	0-4160 mA		

### Product features

	Protection class II		Overvoltage protection
SELV	Low voltage protection		Lamp control gear 110
	Short circuit protection		Suitable for furniture installation
	Overload protection	ErP	Standby-power consumption < 0,5 W
	Overheating protection	LVD	Safety according to EN 61347
	Safety transformer	EMC	Interference suppression + immunity according to EN 55015 + EN 61547
	not dimmable	EMC	Mains harmonics + flicker according to EN 61000-3-2 + EN 61000-3-3

Black fields are applicable / gray fields are not applicable

**Article No.: 862121**

Power supply unit, FLAT, CV, UT12V/50W

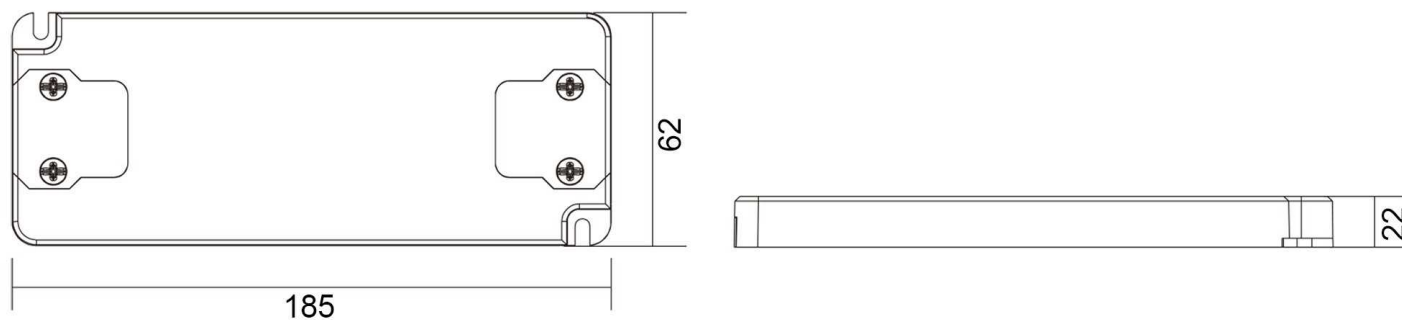
**Dimensions & Weight****Absolute maximum ratings**

Length	185,00 mm	Operating temperature	-20°C - +50°C
Width	62,00 mm	Case temperature	85,00
Height	22,00 mm		
Diameter	0,00 mm		
Product weight	232 g		