

Artikel Nr.: 862177

Netzgerät, BASIC, DIM, Multi CC, EUP30D-1HMC-0, DALI 2.0











IP20 CE

Elektrische Daten

Betriebsart	stromkonstant	Eingangsspannung	220-240V AC/50-60Hz
Leistung	24,70-30,60 W	Leistungsfaktor	0,87
Ausgangsspannung	9-45V DC	Anschlußmöglichkeit	Klemme
Ausgangsstrom	550/600/650/700/750/800/850/900mA		

Produkteigenschaften

	Schutzklasse II		Überspannungsschutz
SELV	Schutzkleinspannung		Lampenbetriebsgerät 110
	Kurzschlußfest		Möbeleinbau nicht geeignet
	Überlastschutz	ErP	Standby-Stromverbrauch < 0,5 W
	Übertemperaturschutz	LVD	Sicherheit nach EN 61347
	Sicherheitstrafo	EMC	Funkentstörung + Störfestigkeit nach EN 55015 + EN 61547
	dimmbar - DALI-Bus nach IEC 62386 DALI 2.0	EMC	Netzstromoberwellen + Flicker nach EN 61000-3-2 + EN 61000-3-3

Schwarze Felder sind zutreffend / graue Felder sind nicht zutreffend

Artikel Nr.: 862177

Netzgerät, BASIC, DIM, Multi CC, EUP30D-1HMC-0, DALI 2.0

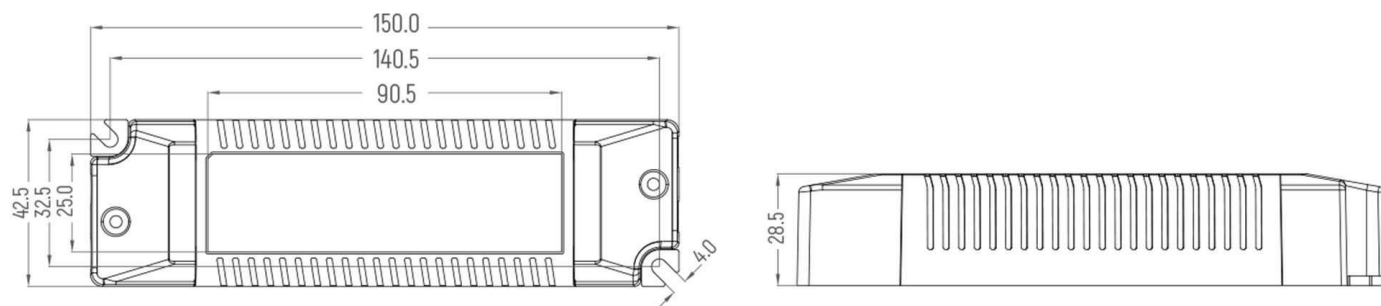
**Abmessungen und Gewicht****Grenzwerte**

Länge	150,00 mm	Betriebstemperatur	-20°C - +50°C
Breite	42,50 mm	Gehäusetemperatur	85 °C
Höhe	28,50 mm		
Durchmesser	0,00 mm		
Gewicht	124 g		

Article No.: 862177

Power supply unit, BASIC, DIM, Multi CC, EUP30D-1HMC-0, DALI 2.0











IP20 

Electrical Characteristics

Operating mode	constant current	Input voltage	220-240V AC/50-60Hz
Power	24,70-30,60 W	Power factor	0,87
Output voltage	9-45V DC	Connection possibility	clamp
Output current	550/600/650/700/750/800/850/900mA		

Product features

	Protection class II		Overvoltage protection
SELV	Low voltage protection		Lamp control gear 110
	Short circuit protection		Not suitable for furniture installation
	Overload protection	ErP	Standby-power consumption < 0,5 W
	Overheating protection	LVD	Safety according to EN 61347
	Safety transformer	EMC	Interference suppression + immunity according to EN 55015 + EN 61547
	dimnable - DALI-Bus according to IEC 62386 DALI 2.0	EMC	Mains harmonics + flicker according to EN 61000-3-2 + EN 61000-3-3

Black fields are applicable / gray fields are not applicable

Article No.: 862177

Power supply unit, BASIC, DIM, Multi CC, EUP30D-1HMC-0, DALI 2.0

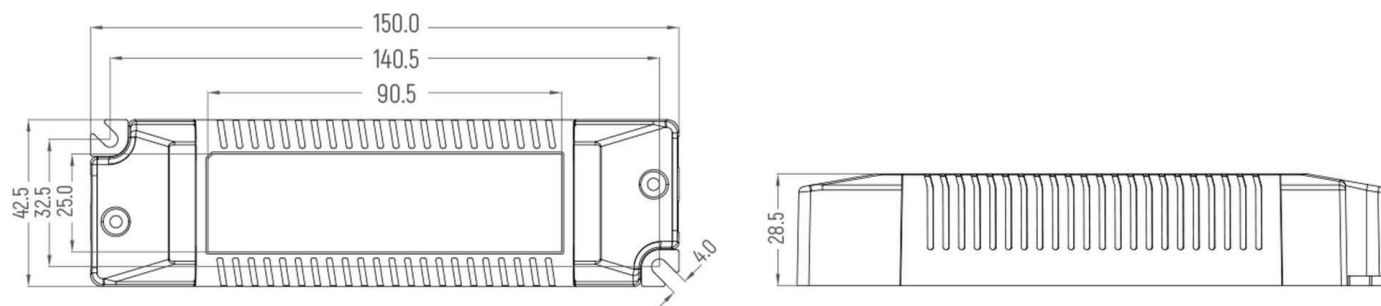
**Dimensions & Weight**

Length	150,00 mm
Width	42,50 mm
Height	28,50 mm
Diameter	0,00 mm
Product weight	124 g

Absolute maximum ratings

Operating temperature	-20°C - +50°C
Case temperature	85 °C