

Artikel Nr.: 872631

Netzgerät, FLAT, CC, UT350mA/12W











IP20 CE

Elektrische Daten

Betriebsart	stromkonstant	Eingangsspannung	220-240V AC/50-60Hz
Leistung	0,70-12,00 W	Leistungsfaktor	0,50C
Ausgangsspannung	2-35V DC	Anschlußmöglichkeit	offene Kabel
Ausgangsstrom	350 mA		

Produkteigenschaften

	Schutzklasse II		Überspannungsschutz
SELV	Schutzkleinspannung		Lampenbetriebsgerät 110
	Kurzschlußfest		Möbeleinbau geeignet
	Überlastschutz	ErP	Standby-Stromverbrauch < 0,5 W
	Übertemperaturschutz	LVD	Sicherheit nach EN 61347
	Sicherheitstrafo	EMC	Funkentstörung + Störfestigkeit nach EN 55015 + EN 61547
	nicht dimmbar	EMC	Netzstromoberwellen + Flicker nach EN 61000-3-2 + EN 61000-3-3

Schwarze Felder sind zutreffend / graue Felder sind nicht zutreffend

Artikel Nr.: 872631

Netzgerät, FLAT, CC, UT350mA/12W

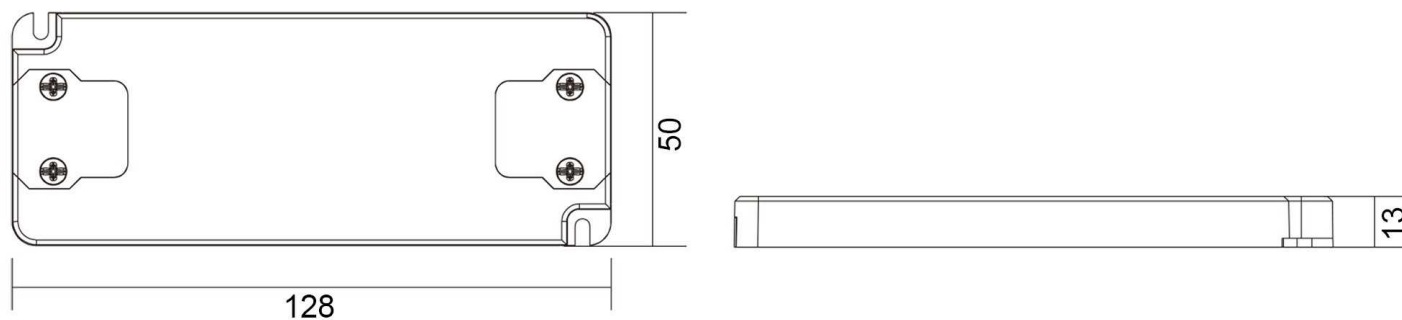
**Abmessungen und Gewicht****Grenzwerte**

Länge	128,00 mm	Betriebstemperatur	-20°C - +50°C
Breite	50,00 mm	Gehäusetemperatur	80,00
Höhe	13,00 mm		
Durchmesser	0,00 mm		
Gewicht	70 g		

Article No.: 872631

Power supply unit, FLAT, CC, UT350mA/12W











IP20 CE

Electrical Characteristics

Operating mode	constant current	Input voltage	220-240V AC/50-60Hz
Power	0,70-12,00 W	Power factor	0,50C
Output voltage	2-35V DC	Connection possibility	wire with open ends
Output current	350 mA		

Product features

 Protection class II	 Overvoltage protection
SELV Low voltage protection	 Lamp control gear 110
 Short circuit protection	 Suitable for furniture installation
 Overload protection	ErP Standby-power consumption < 0,5 W
 Overheating protection	LVD Safety according to EN 61347
 Safety transformer	EMC Interference suppression + immunity according to EN 55015 + EN 61547
 not dimmable	EMC Mains harmonics + flicker according to EN 61000-3-2 + EN 61000-3-3

Black fields are applicable / gray fields are not applicable

Article No.: 872631

Power supply unit, FLAT, CC, UT350mA/12W

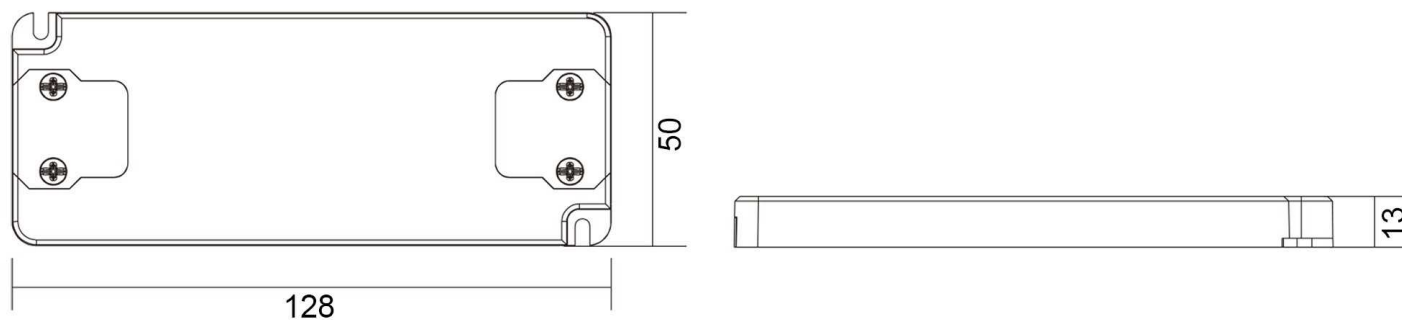
**Dimensions & Weight****Absolute maximum ratings**

Length	128,00 mm	Operating temperature	-20°C - +50°C
Width	50,00 mm	Case temperature	80,00
Height	13,00 mm		
Diameter	0,00 mm		
Product weight	70 g		